

PULSAPRO®

HYDRAULIC DIAPHRAGM METERING PUMP



Flow:
up to 270 gph (1,022 lph)



Pressure:
up to 3,100 psi (214 bar)



Temperature:
up to 250°F (121°C)



Viscosity:
up to 1,000 cPs



EXCEEDING EXPECTATIONS
SINCE 1942

Ex CE API-675

PULSAFEEDER®
ENGINEERED PRODUCTS



PULSAPRO® SERIES

PULSAFEEDER EXPERTISE

For over 75 years, Pulsafeeder, Inc. continues to be a global leader in chemical dosing innovation and fluid handling technology. The PulsaPro Series is the next technological evolution for the Petroleum, Chemical Processing, Energy and Water Treatment markets. PulsaPro builds from its legendary predecessor, Pulsa Series, with expanded performance, improved robustness, and features to simplify operation and maintenance.

PulsaPro pumps are positive displacement reciprocating metering pumps that combine the high efficiency of a plunger pump with the sturdiness of a diaphragm seal to eliminate leakage. They provide maximum accuracy and repeatability with the dependability of a 5 year drive train warranty. Available in a wide range of materials and diaphragm designs, PulsaPro pumps offer a diverse range of fluid handling solutions.

PRODUCT SPECIFICATIONS

- Flows up to 270 gph (1,022 lph)
- Pressures up to 3,100 psi (214 bar)
- Steady state accuracy of +/-0.5% of set point
- Repeatability of +/-0.5% of rated capacity
- Linearity of +/-0.5% of rated capacity
- Full motion stroke length control mechanism
- Manual stroke length capacity control with 10:1 turndown
- Extended 100:1 turndown available
- Fluid temperatures from -10 to 250°F (-23 to 121°C)
- Viscosity up to 1,000 cPs
- Net Positive Inlet Pressure (NPIP) required: 5 psi (0.34 bar)
- Compliant to API-675, CE and ATEX standards
- Diaphragm types: flat, double diaphragm with pressure leak detection, HYDRAtube or HYDRACone
- Modular configurations: simplex, duplex, triplex and multiplex up to 17 pumps
- 4-bolt tie bar
- Connection types: NPT, raised-face flange
- Motor frames: 56C, 143/145TC, 182/184TC, IEC71, IEC80, IEC90

RIES

MATERIALS OF CONSTRUCTION

Wet End: 316LSS, PVC, GF-PTFE, Alloy 20, Alloy C, Monel®, DuplexSS, PVDF, Titanium

Flat Diaphragm: PTFE

HYDRAtube Diaphragm: FKM, CSM, PFA

HYDRAcone Diaphragm: FKM, CSM

Pump Body: Cast Iron

Pump Base: Steel, Stainless Steel

MARKETS & TYPICAL APPLICATIONS

MARKETS:

- Chemical Processing
- Petrochemical
- Oil & Gas
- Power & Energy
- Wastewater Treatment
- Potable Water Treatment
- General Industries

TYPICAL APPLICATIONS

- Amines
- Oxygen Scavengers
- Oil additives
- Demulsifiers
- Methanol
- Corrosion inhibitors
- Anti-scalants
- Defoamers
- Disinfectants
- Acids
- Caustics
- Biocides
- Ethylene Glycol
- Other Chemical Feed

MODELS

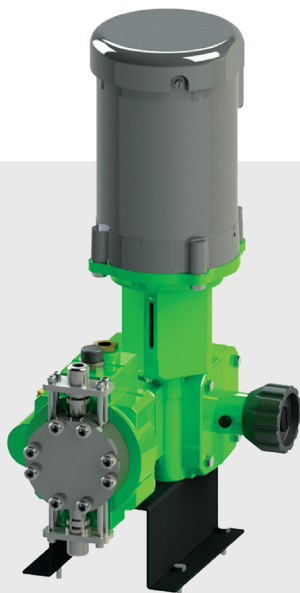

PulsaPro 680

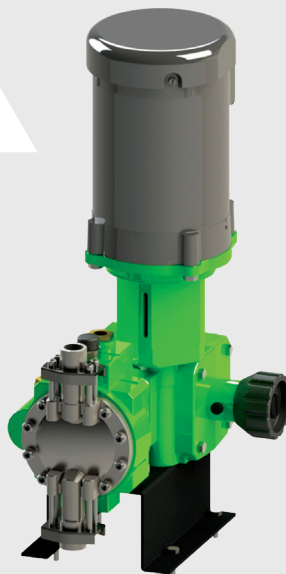

PulsaPro 880



PulsaPro 7120

Monel® is a registered trademark of Special Metals Corporation.

PULSAPRO® TEC

PERFORMANCE

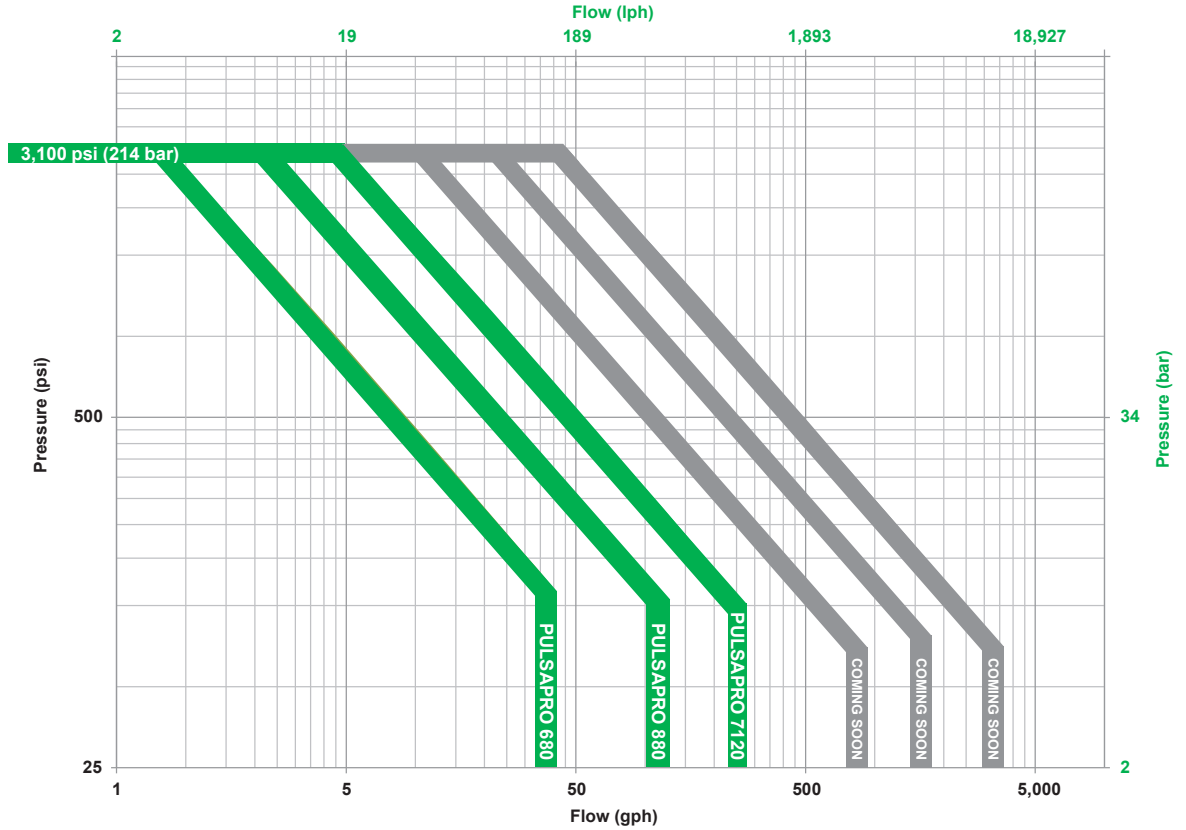

DIMENSIONAL DRAWINGS

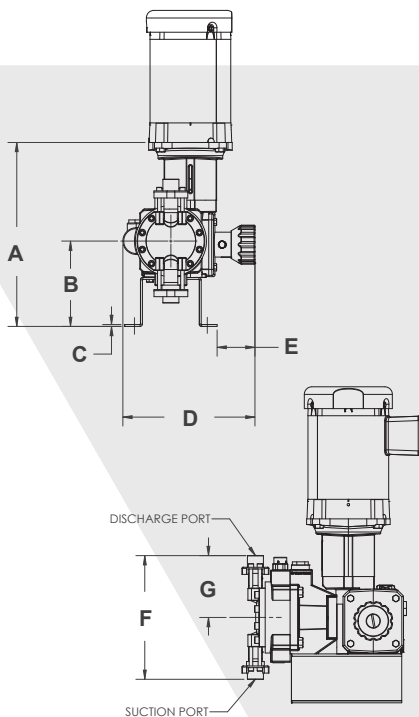

PUMPS	PulsaPro 680	PulsaPro 880	PulsaPro 7120
A - inches	13.59 / 12.11	13.59 / 12.11	15.45 / 13.98
A - mm	345.2 / 307.7	345.2 / 307.7	392.5 / 355.1
B - inches	6.00	6.00	7.76
B - mm	152.4	152.4	197.0
C - inches	0.13	0.13	0.13
C - mm	3.4	3.4	3.4
D - inches	9.29	9.29	11.12
D - mm	235.9	235.9	282.4
E - inches	2.66	2.66	3.83
E - mm	67.6	67.6	97.2
F - inches	16.37 / 8.00	16.37 / 8.00	16.37 / 8.00
F - mm	415.8 / 203.1	415.8 / 203.1	415.8 / 203.1
G - inches	8.19 / 4.00	8.19 / 4.00	8.19 / 4.00
G - mm	207.9 / 101.5	207.9 / 101.5	207.9 / 101.5

Values shown are (max / min)

THE DIMENSIONS GIVEN MAY DIFFER DEPENDING ON PUMP CONFIGURATION."

CHNOLOGY

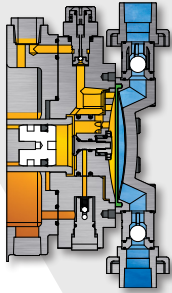

FLAT DIAPHRAGM

The flat diaphragm construction is the standard design ensuring high performance metering in a leak-free operation. PulsaPro diaphragms are available in chemical compatible PTFE to handle a wide range of fluids. As with all PulsaPro diaphragm constructions, the flat diaphragm is hydraulically balanced and operates stress free, providing exceptional life and accuracy.

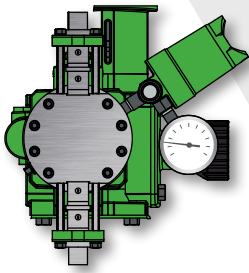

DOUBLE DIAPHRAGM (FLAT) WITH LEAK DETECTION

PulsaPro offers a rugged sandwich-style double diaphragm construction for increased protection against leaks in the case of a system upset that causes the primary diaphragm to fail. PULSAlarm® provides a pressurized leak detection technology to monitor the diaphragm integrity and can signal an alarm or stop the pump at the first sign of diaphragm failure. PULSAlarm® is designed to contain full rated pressure up to 3,000 psi (207 bar), and is rated NEMA Type 7, EEMAC7 Class 1, Division 1, Groups C & D, Class 1, Zone 1, Groups IIA & IIB; UL, cUL, CE, ATEX. An optional pressure gauge is also available for visual indication of diaphragm integrity at the pump.

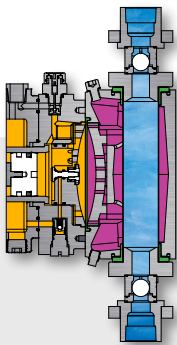

HYDRATUBE®

The HYDRATube® is the choice for sheer sensitive, high viscosity fluids and slurries. Its straight, large, flow through design eliminates clogging and flow restrictions. It offers double diaphragm safety as standard as well as optional slurry valves. Available in FKM, CSM or PFA, it can be utilized with the most corrosive or acidic chemicals. Optional ChemAlarm monitors the electrical conductivity of the intermediate liquid between the HYRDTube® and secondary diaphragm to detect diaphragm failure and, can signal an alarm or stop the pump.

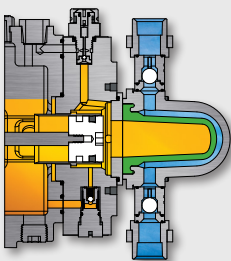

HYDRACONE®

The HYDRACone's self-priming head features a conical elastomer diaphragm. It is particularly well suited for high-lift conditions, high viscosities, and low density slurries. It has a straight, flow through design and optional slurry valves. The HYDRACone® is available in high performance fluorocarbon elastomers.

FEATURES & BENEFITS

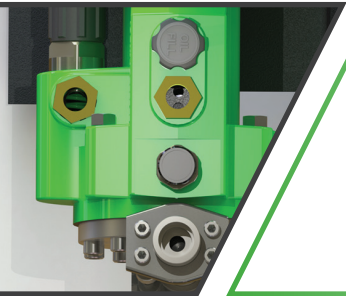

INTUITIVE HYDRAULIC DIAGNOSTICS

- Immediate visual indication of pump performance
- Simple to monitor diaphragm integrity & oil level
- Instantaneous auditing of system overpressurization

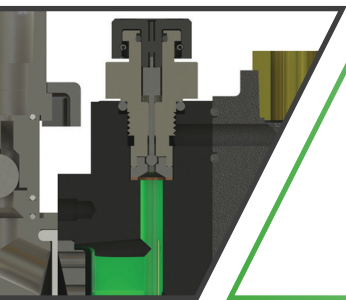

PUSH-TO-PURGE VALVE

- Releases entrained air trapped in the hydraulic oil
- Visual indication of air bleed through diagnostic window
- External spring-loaded button assists in hydraulic fluid priming



HYDRAULIC BYPASS VALVE

- Provides protection for pump overpressurization
- Externally adjustable
- Continuous visual inspection

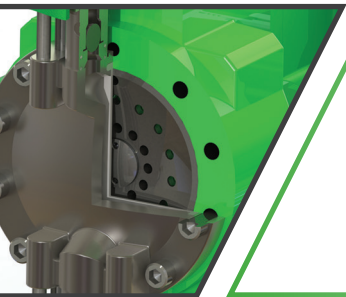

HYDRAULIC PERFORMANCE VALVE

- Provides resilience to system upsets
- Replenishes hydraulic oil on suction stroke only
- Eliminates the need for process side dish plate
- Lowers NPIP requirement to 5 psi

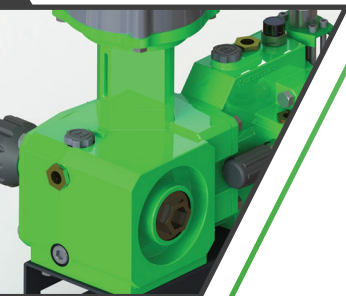

NON-VENTED GEARBOX DESIGN

- Fully sealed, non-vented gearbox prevents ingress of contaminants
- Gearbox meets IP66 rating for use in the harshest environments
- Super compact design allows for installation in the tightest areas

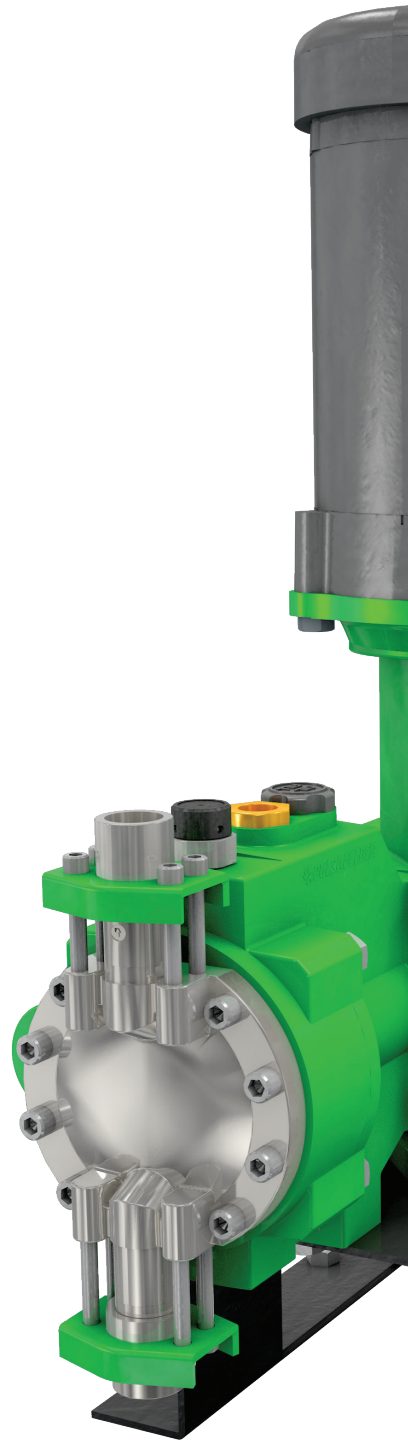

EFITS

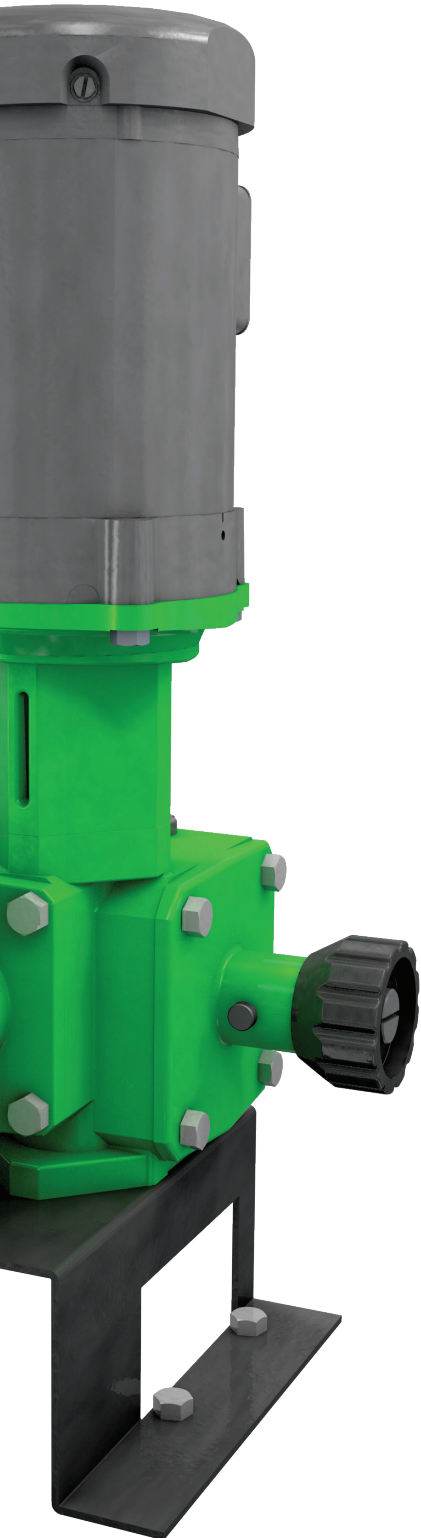

4-BOLT TIE BAR

- Provides stability and resistance to pipe stress
- Helps to promote leak-free operation
- Allows for easy check valve removal without disconnecting piping

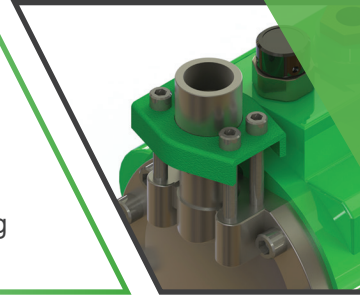

MANUAL STROKE ADJUSTMENT

- Large easy-grip hand wheel with easy-to-read dial
- Adjustable from 0%-100% stroke length
- Resolution of +/-0.5% for accurate control
- Integrated stroke lock mechanism to maintain desired setting

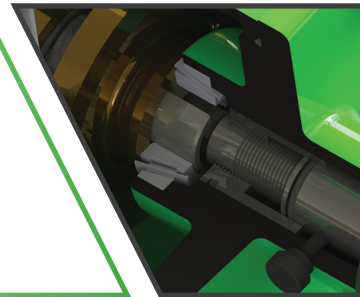

PRECISION BALL VALVE DESIGN

- Knife edge seats
- Accurate, efficient flow transfer
- Simple, three component design

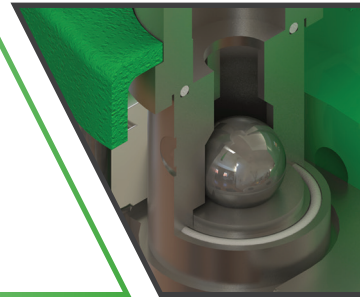

CLOSE-COUPLED DESIGN

- Eliminates the potential for damage due to misalignment
- Maintains low profile and small footprint
- Ease of motor installation and replacement

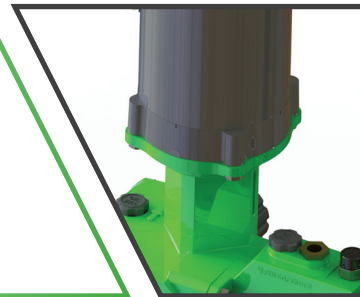

MULTIPLE MOTOR MOUNTING ARRANGEMENTS

- Provide options for placement in existing footprints
- Vertical or horizontal mounting available
- Sturdy, safe and secure

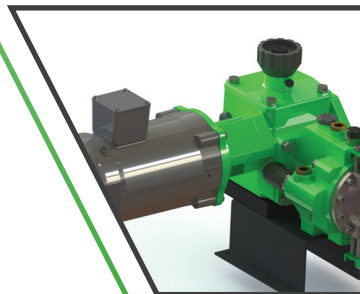

CUSTOM ENGINEERING

ENGINEERED SOLUTIONS

Pulsafeeder, Inc. is a leader in providing metering pump technologies for both stand-alone pumps and skid mounted configurations. By listening to the needs of our customers, Pulsafeeder engineers and fabricates skids to your specifications, and ensures they are compliant with industry and international standards.

We understand that each chemical has its own unique set of challenges that must be taken into consideration in the design, selection, and application of the pump systems. No matter what chemicals you are dosing, safety, reliability, and precise control are required to optimize the chemical reaction and reduce operating costs.

Known for their rugged construction and dependability, our pumps and systems are manufactured to the highest level of performance and quality. Along with providing integrated engineering solutions, we offer full warranty packages along with exceptional after-sales service.



PARTS, KITS & ACCESSORIES



KOPKIT® (KEEP ON PUMPING KIT)

Designed to guard against unnecessary downtime and assure the highest level of efficient and uninterrupted service from your pump. In the event of a breakdown, KOPkit® will put you back in business fast!



METERING PUMP ACCESSORIES:

- Pulsation Dampeners
- Back Pressure Valves
- Pressure Relief Valves
- Calibration Columns
- Y-Strainers



Pulsafeeder, Inc.
2883 Brighton Henrietta Town Line Rd
Rochester, NY 14623
Phone: +1 (585) 292-8000
pulsa@idexcorp.com
pulsa.com

