







# E5 DRUM PUMP

The E5 non-metallic product line has been enhanced to include a Drum Kit assembly and Air Filter / Regulator. The 100% assembled, E5 non-metallic Drum Pump is perfect for transferring liquids from 55-gallon drums. The incorporated Air Filter / Regulator removes moisture and airline contaminants to extend pump service life. It also makes controlling and regulating the drum pump safe and simple, right out of the box.



**DRUM KIT ASSEMBLY**

## Features

-  Portable and lightweight
-  Superior chemical resistance
-  Air Filter / Regulator installed
-  On / Off reliability
-  No assembly required
-  Reliable performance

## Specifications:

**MAX FLOW**  
11 gpm (41.6 lpm)

**MAX SUCTION LIFT**  
12' Dry, 30' Wet

**PORTING**  
Bottom Suction: Downward  
Top Discharge: Side, Vertical, Horizontal

**WETTED AND AIR SECTION**  
Polypropylene

**CONSTRUCTION TYPE**  
Leak-Free Bolted

# PROTECT YOUR INVESTMENT & INCREASE UPTIME

KITS PROVIDE A COMPLETE REPAIR SOLUTION FOR BOTH THE WET AND AIR ENDS OF YOUR PUMP

## Dimensional Drawings:

### E5 Non-Metallic

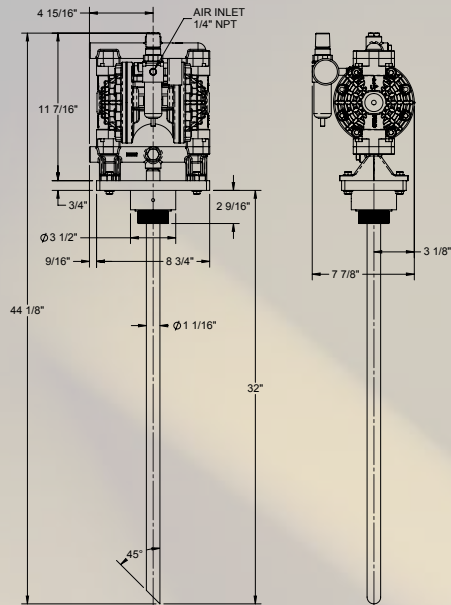

## Specifications:

Pump Model Number	E5PP2R229C-DRUM	E5PP5T5T9C-DRUM	E5PP6X669C-DRUM
Pump Model	E5 Non-Metallic Drum Pump	E5 Non-Metallic Drum Pump	E5 Non-Metallic Drum Pump
Description	Fully Assembled (Pump, Drum Pump Kit, & Air Filter / Regulator)	Fully Assembled (Pump, Drum Pump Kit, & Air Filter / Regulator)	Fully Assembled (Pump, Drum Pump Kit, & Air Filter / Regulator)
Wear Components	Nitrile	PTFE	Santoprene®
Port Size	1/2" NPT	1/2" NPT	1/2" NPT
Max Flow	11 gpm (41.6 lpm)	11 gpm (41.6 lpm)	11 gpm (41.6 lpm)
Max Inlet Pressure	100 psi (7 bar)	100 psi (7 bar)	100 psi (7 bar)
Regulating Pressure Range	0 -100 psi (0 - 7 bar)	0 -100 psi (0 - 7 bar)	0 -100 psi (0 - 7 bar)
Wet End Kit Part Number	E5P BN KIT	E5P TF KIT	E5P XL KIT
Air End Kit Part Number	476.V007.000	476.V007.000	476.V007.000
Air Filter/Regulator Number	020.V103.000	020.V103.000	020.V103.000

## Industries & Applications

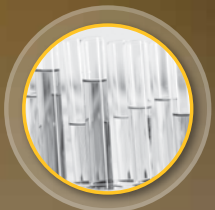

### Chemical

Drum transfer, chemical injection, chemical batching



### Lubrication

Dispensing of oil, windshield solvent, transmission fluid, and anti-freeze



### Metal Finishing

Chemical transfer / dispensing



### Machining

Coolant / cutting oil filtration and dispensing



### Food Processing

Sanitation chemical dispensing



### Pulp and Paper / Corrugation

Glue transfer and dispensing



**VERSA-MATIC®**

Warren Rupp, Inc.  
A Unit of IDEX Corporation  
800 North Main Street  
Mansfield, OH 44902 USA

Phone: 419.526.7296

Fax: 419.526.7289

[versamatic.com](http://www.versamatic.com)

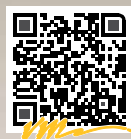

Contact Your Local Distributor to Place Your Order:

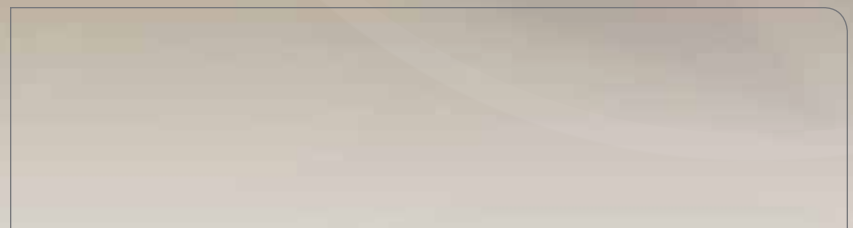

©Copyright 2015 Warren Rupp, Inc. All Rights Reserved.  
Santoprene® is a registered tradename of Exxon Mobil Corp.

vm\_drum\_pump\_flyer-rev0915